

Single room
heating/cooling
and ventilation
unit with heat and
moisture recovery

www.xvent.cz

3in1

XROOM

Beauty in simplicity

Unique solution - ventilation/heating/cooling electric or water exchanger recovery exchanger of heat and moisture easy installation design fits in to each interior available in two sizes

...is unique product containing **ventilation unit and heating/cooling unit in one**. Both systems work independently.

Xroom is manufactured in two sizes **Xroom 100** and **Xroom 250**. These units have wide range of usage in commercial and residential sector f.a. : in hotels, offices, schools, hospitals, apartments, family houses, ...

Xroom is very silent.

The unit matches **Energy class A+**

The unit comes with **CO₂** sensor as standard and enables also **RH** and **Radon** sensors.

Removable **front cover** secured by screws. Available in flat white or anthracite color.



Body of the unit is made from black **EPP**. (expanded polypropylene).



Water exchanger is controlled by thermostatic water valve.
Electric exchanger is controlled by controls of the unit.

EPP filter covers

Two types of recovery exchangers. **Heat recovery** or **heat and moisture recovery**.

Pleated filters are easy accessible. Unit comes with filters class **M5**. Filters class **F7** are available as accessories.

Filter reset button

Metal template enables easy installation. It ensures correct position for drilling of the holes for intake and exhaust and it is also used for hanging of the unit to the wall.

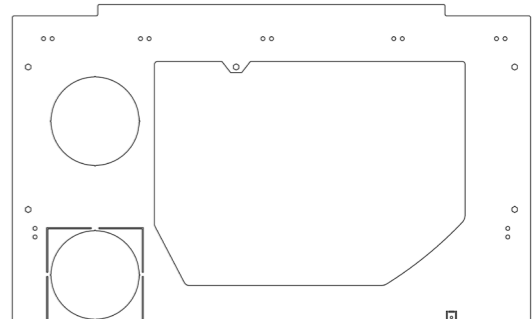

Integrated controls is used for airflow management, heating/cooling performance and switching of the operation modes.



Cut through the wall

- description of air flow

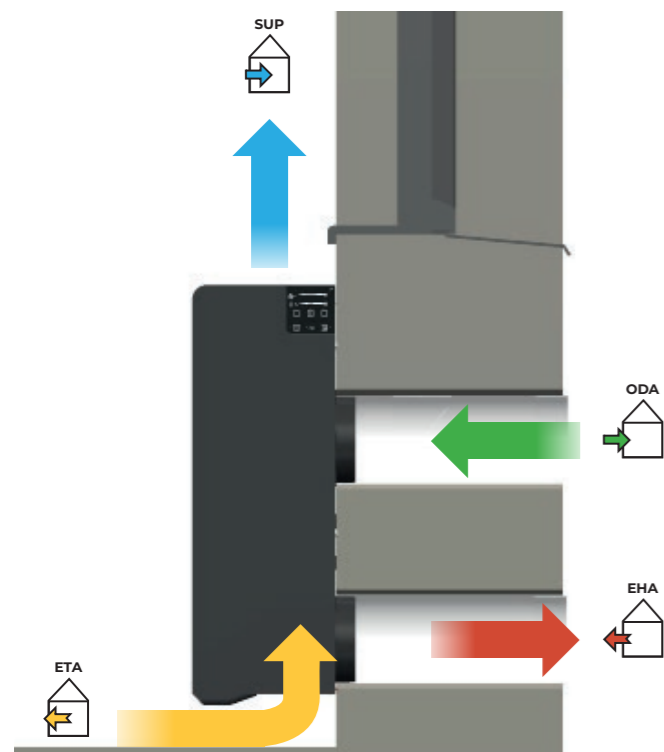
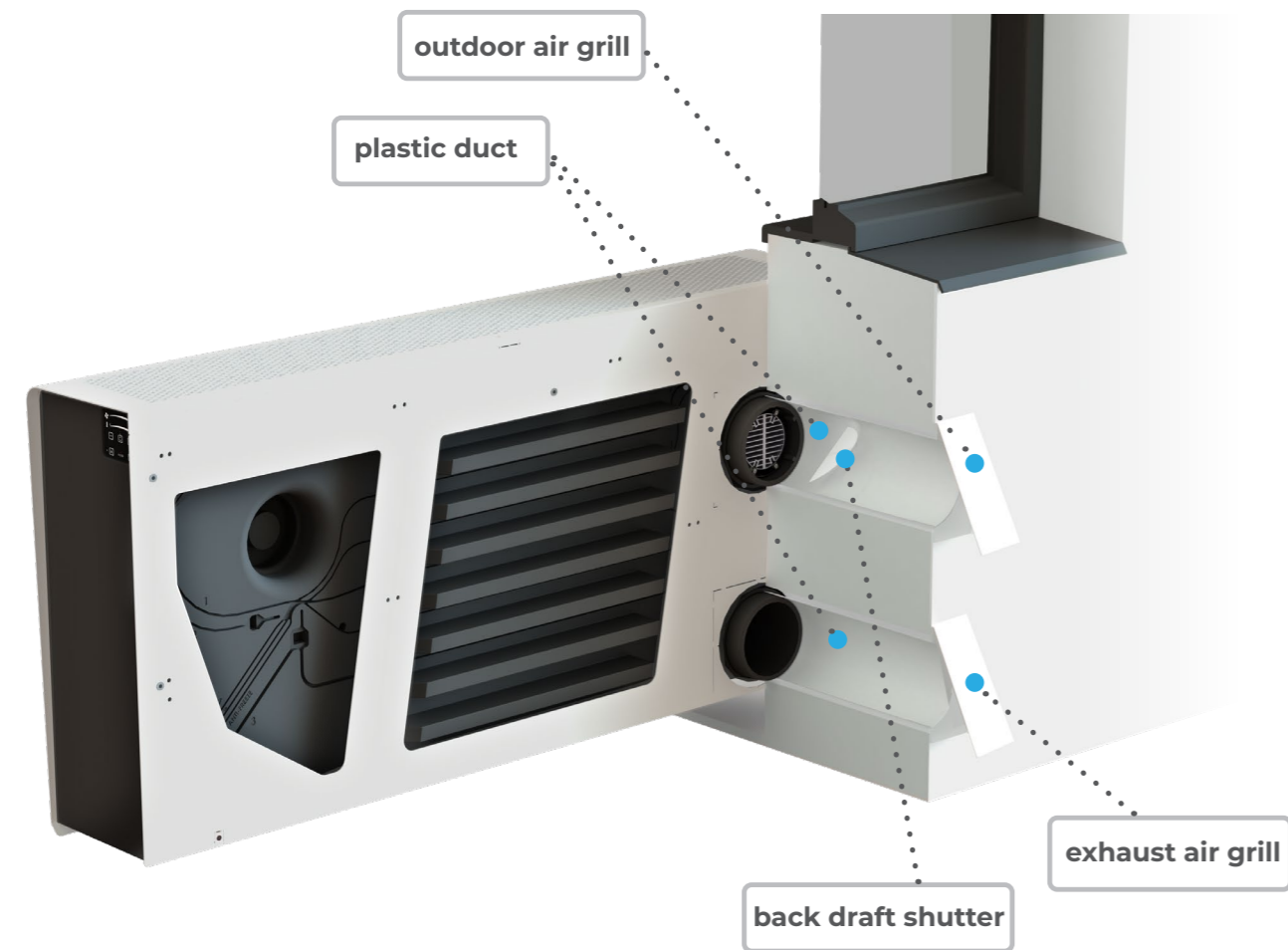

- ODA** - outdoor air (fresh, cold)
- SUP** - supply air to inside (recuperated)
- ETA** - extract indoor air
- EHA** - exhaust air to outside (recuperated)



3in1

...description of the unit and its feature...

The **Xroom** is ventilation unit with heat recovery. Other feature is heating and cooling. The operation of Xroom is managed by CO2 sensor (Xroom ventilates only when the concentration of CO2 in the air inside the room is above hygienic recommended level), or enable manual control according the current feeling. Heating/cooling feature is controlled by thermostat, which manage water or electric exchanger. Both fans operate at minimum level in such case and support the performance of exchanger.

Body of the unit is made from **EPP**. Front design cover is made from aluminium. Xroom is equipped by two energy efficient **EC fans**. The heat exchange between extract and supply air is ensured by recovery exchanger. There are two options. First option is pure heat recovery (Standard exchanger). Second option enables heat recovery with moisture regeneration (Enthalpic exchanger). For the locations with very cold weather, we offer units equipped with **pre-heater** of supplied air. Such a units are protected to get frozen. Supply and extract air is filtered by filters, which are easy to access, when remove the front cover. Xroom is standardly supplied with filters class **M5** (COARSE 70% ISO 16890). If there is request for higher filtration level, it is possible to order filters class **F7** (ePM1 60 % ISO 16890), as an optional accessory. When the filters are clogged, Xroom is signaling replacement need, by flashing diode on the control panel. Replacement of the filters needs to be confirmed by pushing the reset button in the lower part of the unit.

The front cover can be removed by losing two screws with grooved plastic head by hand. Xroom is automatically turned off when the front cover is removed.

The unit is equipped with **electric or water exchanger** for the heating/cooling feature. Water exchanger is controlled by thermostatic valve. Electric exchanger is controlled by thermostat inside the unit and desired temperature can be set on the unit controls.

Control panel is integrated on right side of the unit in upper part. Control panel enables to set air flow rate, cooling by cold night air during summer and temperature setting of the unit with electric heater. It signals filter clogged and its exchange need. It shows also the operation states of the unit, including failure states. Installation of the unit is simple due to supplied installation template. The **installation template** comes to be fixed on the wall and helps to secure the position of the holes to be drilled for supply and exhaust air. Xroom comes to be fixed to the installation template by few threaded-bolts later on.

Xroom is connected with outdoor environment by two holes in the wall fitted with plastic ducts with flaps. Both ducts are fitted by outside grills on the outside wall. The flaps avoid cold draught to enter inside.



Frequently asked questions / Answers

Decentral vs. central ventilation...

Decentral ventilation is mechanical ventilation for one room only. **Central ventilation** is mechanical ventilation of more rooms by once device.

Central ventilation is provided by units with bigger dimensions than units for decentral ventilation, since these has to supply higher air volume. Units for central ventilations are usually located in the technical room where they are not annoying the users by high noise level and they are not blocking any space. Central ventilation systems require ducting for supply and extract air, which are often difficult to place in the way to do not disturb. Central ducting systems require cleaning every year, which is complicated. Cost investment of the installation of ducting and theirs covers are usually in the same level as the purchase price of the ventilation unit. Another aspect is regulation and controlling of these systems in order to achieve minimum operation costs and distribution of the air to there where is needed. The advantage is, that suction and exhaust does not have to be located on the outside wall and if so, there are always only two openings.

Decentral units are used for ventilation of one room only. Theirs dimensions vary from very small ones located in to the wall, to bigger ones with dimensions similar to smaller radiator. These units ventilate only selected rooms and when needed. Theirs advantage is, that these units can be operated according to sensors of quality of the air (Air Quality sensors -AQS), typically by CO2 sensor or relative humidity sensor. Thanks to the sensors the unit ventilates only when the concentration of pollution in the air is above set level – this means "ON DEMAND". This ensure, that the energy consumption during ventilation is at minimum level, about 35% lower than ventilation without sensors. More powerful units can supply in to the room bigger air volume of the air in case of need than central units and thus can ventilate the room faster and better.

It is necessary to consider more suitable solution for each specific project.



What is heat recovery...

Heat recovery generally means backwards usage of the energy. In the case ventilation we talk about heat recovery or eventually about moisture regeneration. Quantity of energy to be saved is expressed by efficiency shown in percentage points and such a value represent quantity of the heat/moisture, what is the unit able to gain from the extracted(exhausted) air and transfer it to supplied (fresh) air. Higher efficiency value means better. This is valid for heat recovery with efficiency up to 85%, because the heat recovery with higher efficiency has trouble with freezing condensate in the exchanger. This fact seriously limits the heat recovery during winter time.

Important fact is, that ventilation with heat recovery saves up to 85% of the heating costs in comparison with ventilation by windows.

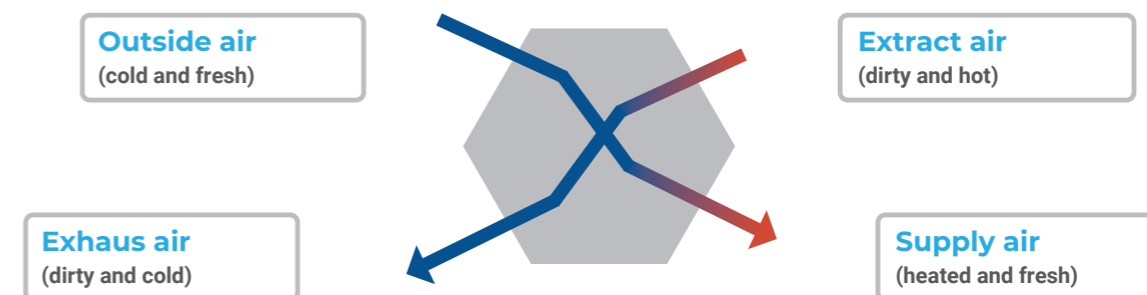

What means enthalpic regeneration...

Enthalpic regeneration (ERV) means backwards gaining of the moisture from the extract air. The supplied air is so dry in the winter, that it can reduce the indoor relative humidity in the air below 20%. Such a low relative humidity cause drying-off the skin, mucous membrane and wood-made furniture and floors. Dry mucous membrane makes breathing less comfortable and cause respiratory diseases. Dehydration of the skin makes wrinkles and the drying-off the wood can damage furniture or floors. Ideal relative humidity inside should be around 50%. The solution is usage of **Enthalpic Recovery Exchanger** (Xvent recommends).

It is important to know that enthalpy heat exchangers always also recover heat.

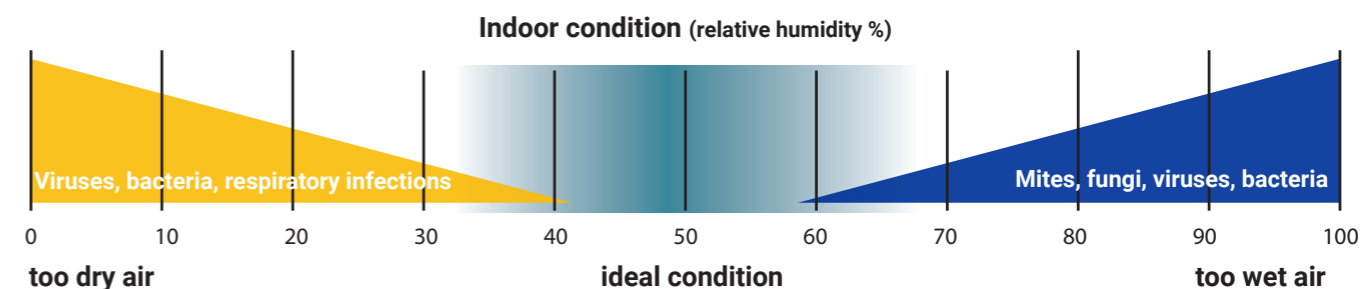

How to choose right size of the unit...

One of the mains parameters of the unit is the air volume which is the unit able to supply in to the room. Value which is usually used for choice, is quantity of the air at one square meter of the floor space. **Manufactures usually used 25m³/h at 20m²**. This is half quantity which ensure healthy climate. For the most cases are better to use quantity of the air need at quantity of the people inside the room. Typical value is **25m³/h/person**.

It is important to choose higher value of both methods in specific case anyway.

Why is mechanical ventilation needed...

Ventilation by windows is in many cases enough (residential areas, alone houses close to the forest), but does not ensure the energy savings (heat in the winter, cold during summer). But if there is noise outside, pollen, annoying smell or freezing conditions, the ventilation by window is not the best solution. Even thought in the summer, if the room is equipped by air conditioner, is the opening the windows not suitable. In all cases mentioned above is the mechanical ventilation senseful solution. If the unit is equipped by heat recovery and/or moisture regeneration, the energy savings reach 85%, which will have to be supplied by heating or by cooling device otherwise.

It is important to consider if the priority is price or health.

What means 3 in 1...

3in1

Xroom is designed to be ventilation unit and the heating/cooling unit as well. The ventilation operation and the heating/cooling operation works independently one on each other. This means, that during ventilation request the heating does not have to work and oppositely. All systems can operate at same time as well. The water and electric heater do not operate as the post heaters only, they operate as solid-regular air heaters. **It is good to know, that Xroom unit 3in1 can replace the radiator (or electric convector) and save the space thus.**



Why sensors (air quality sensors)...

Sensors enable automatic operation of the unit. The unit operates only, when the inside quality of the air is worse than requested. When fulfilling the air quality request, such a solution generate only minimum ventilation costs in the real operations! This also means lower operation costs and faster paid back of the investment to ventilation unit purchase. Xroom enables connection of **CO2 sensor, RH sensor and radon sensor.** **It is important to consider, if the more important are operation costs, or purchase investment.**

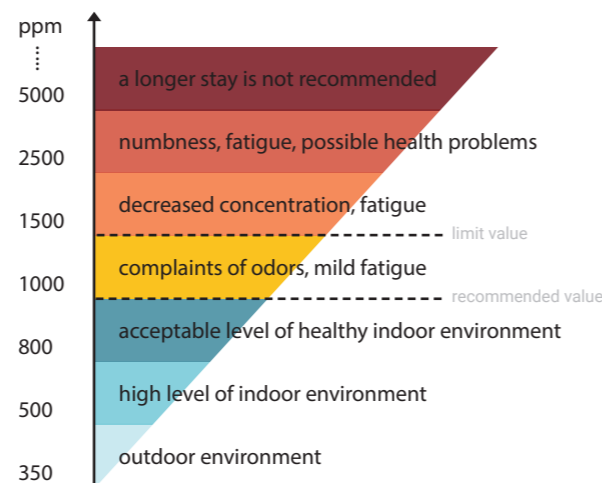

What are the operation costs...

Operation costs are generated by heating costs, costs to operate the fans and by maintenance and service costs. Heating costs are lower about 85% in comparison with ventilation by windows for the same time period. Operation costs of the fans are thanks to the EC fans 1 EUR/month when considering average usage four hours a day every day. Costs of filter replacement are around 10 EUR/month when replaced twice a year.

How complicated is the installation...

Installation of the unit is simplified, that handyman can install it by him self. Installation does not require any specialist. The metal installation template, which is part of the delivery, is fixed to the wall by few wall-plugs and screws. There has to be drilled out two holes in to the wall according to two cut outs in the template. (This is most difficult part of the installation). There are specialists for drilling the holes in to the wall and it is good idea to hire them. Plastic ducts comes to be fitted in to the holes in the wall then according to the manual. Plastic ducts comes to be cut out based on the thickness of the wall. Ducts in the wall comes to be fixed by installation foam and the outlet grill comes to be attached to the outside wall. The body of the unit comes to be fixed to the installation template by bolts and secured by nuts. Unit with water exchanger is equipped with flexible hoses, which comes to be connected to the heating pipe system with thermostatic valve. Electrical cable is plugged in to the socket, front cover comes to put on and that's it. Total installation time is no longer than two hours. **It is important to read the installation manual or to watch the installation video, which you can find at our webpage or at Youtube.com.**

How difficult is the maintenance...

The Xroom is designed to be maintenance free. Only thing needs to be under the control is filter clogging. Good condition of the filters ensures smooth operation and stable high level heat recovery and moisture regeneration. Clogged filter is signal by flashing diode "filter" on the control panel. In such case is necessary to follow the operation manual. The front cover comes to remove and by opening two plugins with inscription "FILTER" is possible to access and replace these filters by new clean ones. The replacement of the filters to be confirmed by pushing the RESET button and that's it.

It can not be easier.

What are the units "PUSH-PULL".....

Those units use accumulation of the heat in the porous material, thru which fresh air flows. The units are controlled in the way, that one minute the unit extracts the hot air from the room thru the exchanger and the heat exchanger gets heated. Exactly the same long time period the unit supply air in opposite way thru the hot exchanger, from which the air gets heated. These units are popular due to its low price. It is good to know the important facts, which suppliers do not show: -Real average efficiency of such a device is not higher than 50%. Stated value around 90% is valid only few seconds after the air flow direction change.

-Air exchange inside the room (ventilation intensity) is half of the stated value, because supply of the air takes only one half of the operation time period.

From the mentioned above is clear, that these units are not comparable with standard heat recovery units using plate or rotary heat exchangers.



for example:
heat recovery unit
SEVi 160 Standard

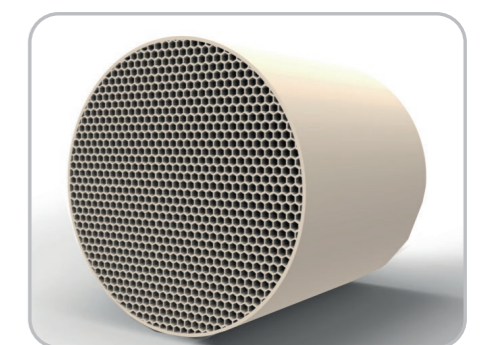

ceramic exchanger

Control description Xroom



AUTOMAT/MANUAL

By pressing the button, you come to the manual mode – ventilation is manually controlled by user, out-puts from the AQS sensors are ignored. By pushing the button once again you can active automatic mode – ventilation on demand based on AQS sensors.

FILTERS CLOGGING

Indication of clogged filter is activated by timer, roughly after 6 month operations (only if the units ventilate). Indication is signaled by red diode flashing.

WATER VERSION / AMBIENTE VERSION

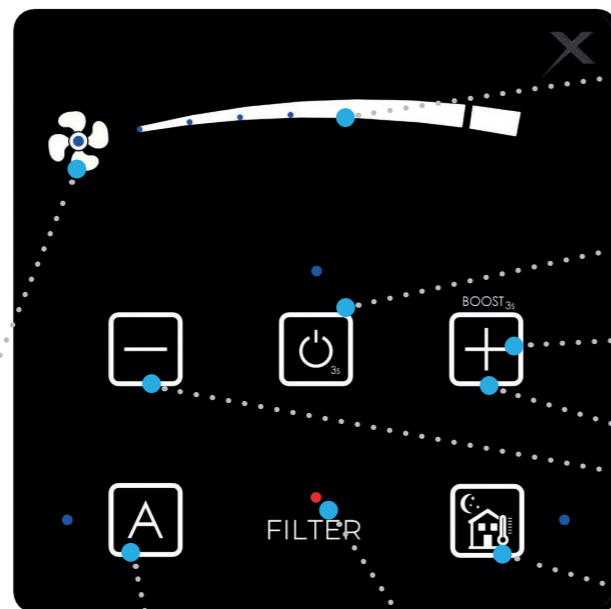

Fan status diode

Automat / manual switching

Filter clogging diode

ELECTRIC VERSION

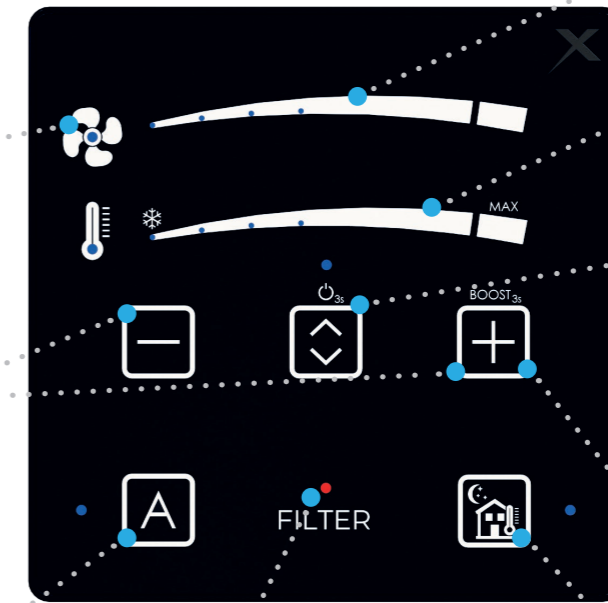

Fan status diode

Setting of airflow and temperature

Automat / manual switching

Filter clogging diode

Indicator of air flow setting

Indicator of heating/cooling setting

ON/OFF / switching setting modes

BOOST mode - 3s holding of button

Night cooling activation

Indicator of air flow setting

ON/OFF

BOOST mode - 3s holding of button

Air flow setting

Night cooling activation

NIGHT COOLING

Activate the night cooling function by pressing the button. The night cooling is used for cooling down the room in the summer by cold night air. This function is active for 8h from activation. Intensity of the supplied air is possible to change during function run. Once the function is over the values comes back to the previous setting.

BOOST MODE

By pressing the button for 3sec the intensive ventilation will start for 10minutes period. Shall you wish to turn off this regime within 10 minutes, press the button for 3 sec once again and the unit comes to the setting used before.

Technical data Xroom

VENTILATION AND HEATING UNIT WITH HEAT AND HUMIDITY RECOVERY

Xroom-100-heat and moisture recovery efficiency										
Type	XR1-010-ECxxHR...				XR1-010-ECxxER...					
Type of recovery exchanger	HRV (heat recovery)				ERV (enthalpy recovery)					
	Flow (m3/h)	HR efficiency (%)	Current(A)	Power input (W)	Flow (m3/h)	HR efficiency (%)	ER efficiency (%)	Current(A)	Power input (W)	
AirFlow - setting	1.	28	87	0,13	10	25	90	85	0,13	10
	2.	41	85,1	0,14	11	35	89	81	0,14	11
	3.	53	83,5	0,15	14	47	84	75	0,15	14
	4.	66	81,7	0,18	17	58	81	69	0,18	17
	5.	78	80	0,21	21	69	78	63	0,21	21
	6.	90	78,3	0,26	26	80	76	58	0,26	26
	7. - nominal	100	77	0,3	30	90	75	55	0,3	30
	8. - boost	215	n/a	1,32	167	205	n/a	n/a	1,32	167

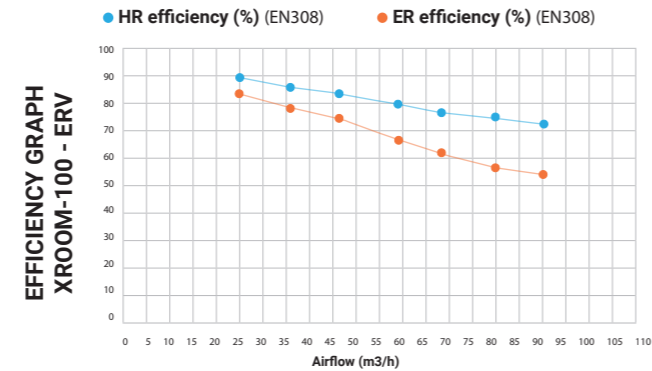
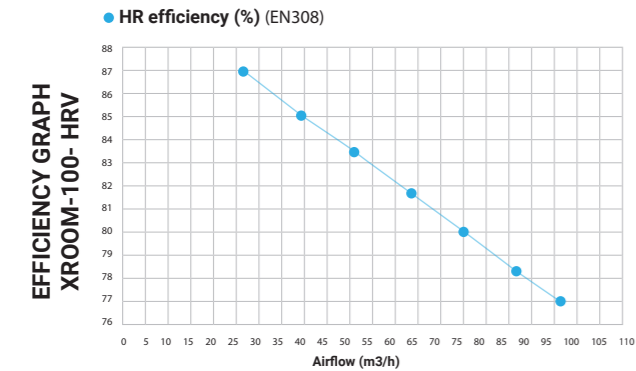

Xroom-250-heat and moisture recovery efficiency										
Type	XR1-025-ECxxHR...				XR1-025-ECxxER...					
Type of recovery exchanger	HRV (heat recovery)				ERV (enthalpy recovery)					
	Flow (m3/h)	HR efficiency (%)	Current(A)	Power input (W)	Flow (m3/h)	HR efficiency (%)	ER efficiency (%)	Current(A)	Power input (W)	
AirFlow - setting	1.	64	86,1	0,17	13,5	62	85	73	0,17	13,5
	2.	95	85	0,20	17	92	82,5	70	0,2	17
	3.	126	84	0,25	23	121	81	67	0,25	23
	4.	157	83	0,32	30	151	79,5	64	0,32	30
	5.	188	82	0,45	40	180	78	60,5	0,45	40
	6.	219	81	0,52	51	210	76,5	58	0,52	51
	7. - nominal	250	80,5	0,61	61	240	75	54,5	0,61	60
	8. - boost	350	n/a	1,42	169	335	n/a	n/a	1,42	167

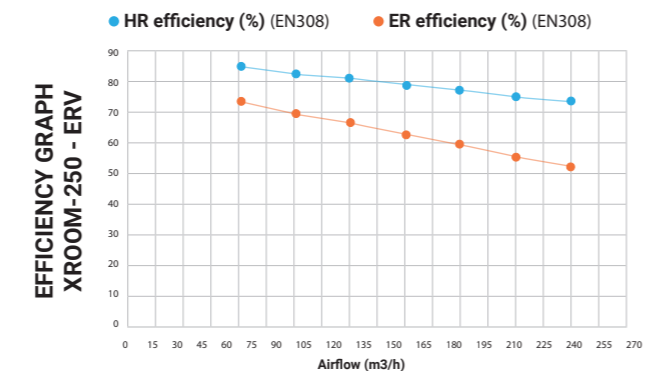
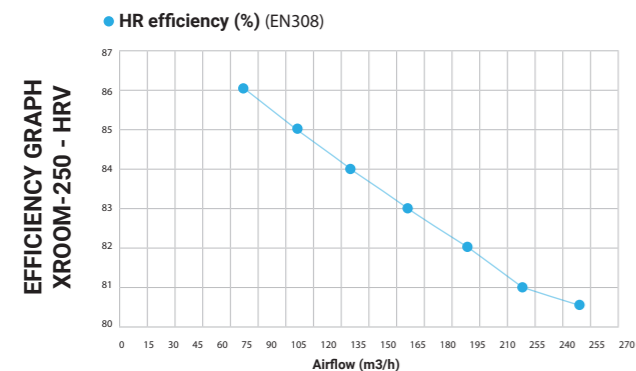

XROOM-100 a XROOM-250

XROOM-100		XR1-010-ECS0..X...		XR1-010-ECVx..X...		XR1-010-ECE1..X...		XR1-010-ECS0..P...		XR1-010-ECVx..P...		XR1-010-ECE1..P...		
Type of recovery exchanger		HRV	ERV	HRV	ERV	HRV	ERV	HRV	ERV	HRV	ERV	HRV	ERV	
Unit equipment	preheater	-	-	-	-	-	-	-	-	-	-	electric (0,27kW)		
	heating/cooling	-	-	water heat	electric	-	-	water heat	electric	-	-	-	-	
Nominal airflow / boost*	m3/h	100 / 215 (HRV) , 90 / 205 (ERV)												
Heating output range**	kW	-	-	0,33 - 1,38	0,5	--	--	0,33 - 1,38	0,5	-	-	-	-	
Cooling output range*****	kW	-	-	0,18- 1,4	-	--	--	0,18-1,4	-	-	-	-	-	
Noise level***	dB (A)	32,1												
Weight****	kg	16,3	-	18,3	-	19,3	-	16,8	-	18,8	-	19,8	-	
Volume of water in the exchanger	l	-	-	0,51	-	-	-	-	-	0,51	-	-	-	
Power supply	V/Hz	1 ~ 230 / 50-60												
Nominal power input / boost*	W	30 / 167	-	30 / 165	-	530 / 667	-	300 / 437	-	300 / 437	-	800 / 937	-	
Nominal current / boost*	A	0,3 / 1,32	-	0,3 / 1,32	-	2,5 / 3,5	-	1,5 / 2,5	-	1,5 / 2,5	-	3,7 / 4,7	-	
Recovery efficiency EN308	heat	%	87	90	87	90	87	90	87	90	87	90	87	90
	moisture	%	-	85	-	85	-	85	-	85	-	85	-	85
Protection	IP	20												

XROOM-250		XR1-025-ECS0..X...		XR1-025-ECVx..X...		XR1-025-ECE1..X...		XR1-025-ECS0..P...		XR1-025-ECVx..P...		XR1-025-ECE1..P...	
Type of recovery exchanger		HRV	ERV	HRV	ERV	HRV	ERV	HRV	ERV	HRV	ERV	HRV	ERV
Unit equipment	preheater	-	-	-	-	-	-	-	-	-	-	electric (0,54kW)	
	heating/cooling	-	-	water	electric	-	-	water	electric	-	-	-	-
Nominal airflow / boost*	m3/h	250/ 350 (HRV) , 240 / 335 (ERV)											
Heating output range**	kW	-	-	1,34 - 3,49	1	--	--	1,34 - 3,49	1	-	-	-	-
Cooling output range*****	kW	-	-	0,3-3	-	--	--	0,3-3	-	-	-	-	-
Noise level***	dB (A)	32,6											
Weight****	kg	36	-	39,4	-	41,2	-	37	-	40,4	-	42,2	-
Volume of water in the exchanger	l	-	-	1,17	-	-	-	-	-	1,17	-	-	-
Power supply	V/Hz	1 ~ 230 / 50-60											
Nominal power input / boost*	W	0,59 / 169	-	0,59/ 169	-	1061 / 1169	-	479 / 709	-	480 / 709	-	1480 / 1709	-
Nominal current / boost*	A	0,61 / 1,42	-	0,61 / 1,42	-	5 / 5,8	-	3 / 3,8	-	3 / 3,8	-	7,3 / 8,2	-
Recovery efficiency EN308	heat	%	87	86	87	86	87	86	87	86	87	86	87
	moisture	%	-	75	-	75	-	75	-	75	-	75	-

* BOOST(intensive ventilation - 10min),
 ** water temperature 75/60°C, inlet air temperature 20°C
 *** sound pressure level in 3m (free space),
 **** unit weight (without water and packaging)
 ***** water temperature 7/12°C, inlet air temperature 24°C (indoor condition 23°C extract / 30°C supply) - be careful for fluid pressure drop



Room ventilation scheme

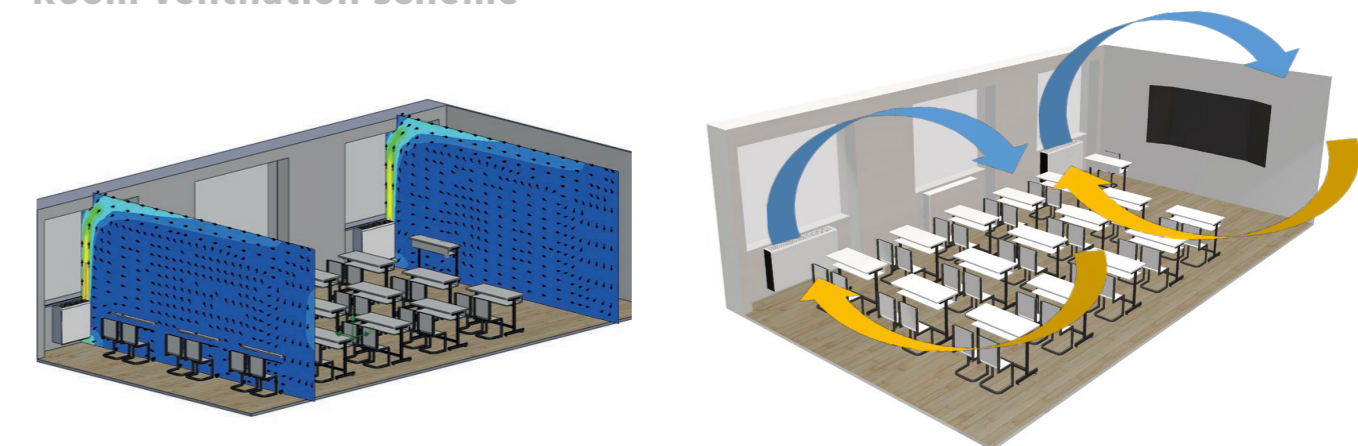

Data - ACOUSTICS



XROOM-100

XR1-010-EC... - radiating the unit into the interior (inside the room)								Sound power level LWA (dB A)	Sound pressure level in a free field on a reflecting plane		
Airflow - setting		125 Hz	250 Hz	500 Hz	1 kHz	2 kHz	4 kHz		8 kHz	LPA (dB) in 1m	LPA (dB) in 3m
1. (min/heating mode)	dB	21,5	25,9	29,7	27,6	21	18,7	17,5	33,7	19,8	12,1
4.		28,8	43,4	41,3	39,4	34,3	24,3	18	47	33,1	25,5
7. (nominal airflow)		32	49,1	48,7	46,9	43	33,2	23,1	53,6	39,7	32,1
Boost *		42	56,9	67,1	62,4	59,5	51,9	45,2	69,3	55,4	47,8

XR1-010-EC... - radiating the unit to the exterior (intake, exhaust outside)								Sound power level LWA (dB A)	Sound pressure level in a free field on a reflecting plane		
Airflow - setting		125 Hz	250 Hz	500 Hz	1 kHz	2 kHz	4 kHz		8 kHz	LPA (dB) in 1m	LPA (dB) in 3m
1. (min/heating mode)	dB	34,7	32,1	35,8	32,2	22	22,3	24,7	37,3	23,7	14,6
4.		46,4	53,7	49,7	45,9	35,9	28,9	25,4	52,1	39,6	30,8
7. (nominal airflow)		51,7	60,7	58,6	54,6	45	39,5	32,5	59,4	47,5	38,7
Boost *		67,7	70,4	80,8	72,7	62,3	61,8	63,6	76,8	66,3	57,6

XROOM-250

XR1-025-EC... - radiating the unit into the interior (inside the room)								Sound power level LWA (dB A)	Sound pressure level in a free field on a reflecting plane		
Airflow - setting		125 Hz	250 Hz	500 Hz	1 kHz	2 kHz	4 kHz		8 kHz	LPA (dB) in 1m	LPA (dB) in 3m
1. (min/heating mode)	dB	18,6	29,5	28,9	25,7	22,2	15,8	13,3	34,4	20,1	12,7
4.		23,5	42,6	42	37,6	33,8	21,9	13,2	46,3	31,9	24,5
7. (nominal airflow)		27,9	48,8	50,9	46,2	43,2	33,1	19,7	54,2	39,8	32,6
Boost *		37,6	56,6	62,9	59,6	56,8	47,7	36,8	65,9	51,5	44,2

XR1-025-EC... - radiating the unit to the exterior (intake, exhaust outside)								Sound power level LWA (dB A)	Sound pressure level in a free field on a reflecting plane		
Airflow - setting		125 Hz	250 Hz	500 Hz	1 kHz	2 kHz	4 kHz		8 kHz	LPA (dB) in 1m	LPA (dB) in 3m
1. (min/heating mode)	dB	30	36,5	34,8	29,9	23,3	18,9	18,7	38,1	24	15,3
4.		37,9	53,6	50,6	43,8	35,4	26	18,7	51,3	38,2	29,6
7. (nominal airflow)		45,1	60,4	61,3	53,8	45,2	39,4	27,7	60,1	47,6	39,3
Boost *		60,7	70,1	75,7	69,4	59,5	56,8	51,8	73,1	61,6	53,3

Throughput sound from the exterior				
Airflow - setting	Xroom-100		Xroom-250	
	Evaluated acoustic attenuation	Evaluated difference of the standard level	Evaluated acoustic attenuation	Evaluated difference of the standard level
	RW,P (C,Ctr) [dB]	Dn, e, w (C,Ctr) [dB]	RW,P (C,Ctr) [dB]	Dn, e, w (C,Ctr) [dB]
Stand-by	17 (-1; -3)	42 (-2; -3)	17 (-1; -3)	42 (-2; -3)
7. (nominal airflow)	17 (-1; -3)	42 (-2; -3)	17 (-1; -3)	42 (-2; -3)

Data - WATER EXCHANGER - HEATING



Maximum usable water temperature **80 °C**

Maximum operating pressure for the heater **1.6 MPa**

The connection dimension of both heat exchangers is an external thread **G 3/4"**

XROOM-100-HRV

Air intake temperature*	Airflow	80/60				75/65				75/60			
		Heating output	Exhaust air temperature	Water flow	Water pressure drop	Heating output	Exhaust air temperature	Water flow	Water pressure drop	Heating output	Exhaust air temperature	Water flow	Water pressure drop
°C	m3/h	kW	°C	m3/h	kPa	kW	°C	m3/h	kPa	kW	°C	m3/h	kPa
10	1. (min/heating mode)	0,47	75,3	0,02	0,2	0,42	72,9	0,03	0,4	0,42	71,6	0,03	0,4
	4.	1,25	65,7	0,06	1	1,26	64,7	0,11	3,2	1,22	63	0,07	1,5
	7. (nominal airflow)	1,78	60,6	0,08	1,7	1,76	60,1	0,16	5,8	1,7	58,3	0,1	2,7
15	1. (min/heating mode)	0,4	74,9	0,01	0,2	0,38	72,9	0,04	0,6	0,38	71,7	0,02	0,3
	4.	1,16	66,5	0,05	0,8	1,14	65,5	0,1	2,7	1,1	63,7	0,06	1,3
	7. (nominal airflow)	1,62	61,7	0,07	1,2	1,6	61,3	0,14	4,9	1,54	59,4	0,09	2,3
20	1. (min/heating mode)	0,35	74,9	0,01	0,2	0,35	73	0,03	0,5	0,33	71,5	0,02	0,2
	4.	1,05	67,1	0,05	0,7	1,03	66,2	0,09	2,3	0,99	64,5	0,06	1
	7. (nominal airflow)	1,46	62,7	0,06	1,2	1,44	62,4	0,13	4,1	1,38	60,5	0,08	1,9

Air intake temperature*	Airflow	70/60				70/50				65/50			
		Heating output	Exhaust air temperature	Water flow	Water pressure drop	Heating output	Exhaust air temperature	Water flow	Water pressure drop	Heating output	Exhaust air temperature	Water flow	Water pressure drop
°C	m3/h	kW	°C	m3/h	kPa	kW	°C	m3/h	kPa	kW	°C	m3/h	kPa
10	1. (min/heating mode)	0,39	67,8	0,04	0,6	0,37	64,1	0,01	0,2	0,35	60,9	0,02	0,3
	4.	1,15	60,2	0,1	2,8	1,07	56,3	0,05	0,7	0,68	57,4	0,04	0,6
	7. (nominal airflow)	1,62	56	0,14	5,1	1,48	52	0,06	1,3	1,4	49,8	0,08	2
15	1. (min/heating mode)	0,34	67,9	0,03	0,6	0,33	64,2	0,02	0,2	0,31	60,9	0,03	0,2
	4.	1,04	60,9	0,09	2,3	0,95	56,8	0,04	0,6	0,6	57,7	0,04	0,4
	7. (nominal airflow)	1,41	57,1	0,13	4,2	1,32	53	0,06	1,1	1,24	50,9	0,07	1,6
20	1. (min/heating mode)	0,31	67,9	0,02	0,5	0,29	64,2	0,01	0,1	0,26	60,8	0,01	0,2
	4.	0,93	61,7	0,08	1,9	0,83	57,2	0,04	0,5	0,52	57,9	0,3	0,4
	7. (nominal airflow)	1,3	58,1	0,11	3,5	1,16	53,9	0,05	0,8	1,09	51,8	0,06	1,3

Air intake temperature*	Airflow	55/45				45/35				40/30			
		Heating output	Exhaust air temperature	Water flow	Water pressure drop	Heating output	Exhaust air temperature	Water flow	Water pressure drop	Heating output	Exhaust air temperature	Water flow	Water pressure drop
°C	m3/h	kW	°C	m3/h	kPa	kW	°C	m3/h	kPa	kW	°C	m3/h	kPa
10	1. (min/heating mode)	0,28	52,4	0,03	0,4	0,21	41,9	0,03	0,2	0,18	36,8	0,02	0,1
	4.	0,56	49,5	0,05	0,8	0,42	39,6	0,04	0,5	0,35	34,6	0,03	0,3
	7. (nominal airflow)	1,17	43,4	0,1	3,1	0,88	34,9	0,08	1,9	0,72	30,4	0,06	1,4
15	1. (min/heating mode)	0,25	52,3	0,02	0,3	0,19	41,9	0,02	0,1	0,15	36,9	0,01	0,1
	4.	0,49	49,8	0,04	0,7	0,35	39,8	0,03	0,3	0,28	34,9	0,02	0,2
	7. (nominal airflow)	1,02	44,4	0,09	2,4	0,72	35,8	0,06	1,3	0,56	31,1	0,05	0,9
20	1. (min/heating mode)	0,2	52,1	0,03	0,2	0,16	42,1	0,01	0,1	0,12	36,9	0,01	0,1
	4.	0,41	50	0,04	0,5	0,28	40,1	0,02	0,2	0,21	35,1	0,02	0,2
	7. (nominal airflow)	0,86	45,4	0,08	1,8	0,56	36,4	0,05	0,9	0,4	31,8	0,03	0,3

Data - WATER EXCHANGER - HEATING



XROOM-100-ERV

		80/60				75/65				75/60			
Air intake temperature*	Airflow	Heating output	Exhaust air temperature	Water flow	Water pressure drop	Heating output	Exhaust air temperature	Water flow	Water pressure drop	Heating output	Exhaust air temperature	Water flow	Water pressure drop
°C	m3/h	kW	°C	m3/h	kPa	kW	°C	m3/h	kPa	kW	°C	m3/h	kPa
10	1. (min/heating mode)	0,42	67,77	0,02	0,2	0,38	65,61	0,03	0,5	0,38	64,44	0,03	0,3
	4.	1,13	59,13	0,05	0,9	1,13	58,23	0,1	2,88	1,1	56,7	0,06	1,35
	7. (nominal airflow)	1,6	54,54	0,07	1,53	1,58	54,09	0,14	5,22	1,53	52,47	0,09	2,43
15	1. (min/heating mode)	0,36	67,41	0,01	0,2	0,34	65,61	0,04	0,6	0,34	64,53	0,2	0,2
	4.	1,04	59,85	0,05	0,72	1,03	58,95	0,09	2,43	0,99	54,33	0,05	1,17
	7. (nominal airflow)	1,46	55,53	0,06	1,08	1,44	55,17	0,13	4,41	1,39	53,46	0,08	2,07
20	1. (min/heating mode)	0,32	67,41	0,01	0,1	0,32	65,7	0,03	0,5	0,3	64,35	0,02	0,2
	4.	0,95	60,39	0,05	0,63	0,93	59,58	0,08	2,07	0,89	58,05	0,05	0,9
	7. (nominal airflow)	1,31	56,43	0,05	1,08	1,3	56,16	0,12	3,69	1,24	54,45	0,07	1,71

		70/60				70/50				65/50			
Air intake temperature*	Airflow	Heating output	Exhaust air temperature	Water flow	Water pressure drop	Heating output	Exhaust air temperature	Water flow	Water pressure drop	Heating output	Exhaust air temperature	Water flow	Water pressure drop
°C	m3/h	kW	°C	m3/h	kPa	kW	°C	m3/h	kPa	kW	°C	m3/h	kPa
10	1. (min/heating mode)	0,35	61,02	0,04	0,6	0,33	57,69	0,01	0,20	0,32	54,81	0,02	0,2
	4.	1,04	54,18	0,09	2,52	0,96	50,67	0,05	0,63	0,91	48,51	0,05	0,99
	7. (nominal airflow)	1,46	50,4	0,13	4,59	1,33	46,8	0,05	1,17	1,26	44,82	0,07	1,8
15	1. (min/heating mode)	0,31	61,11	0,03	0,5	0,3	57,78	0,02	0,1	0,28	54,81	0,03	0,2
	4.	0,94	54,81	0,08	2,07	0,86	51,12	0,04	0,54	0,8	49,05	0,05	0,81
	7. (nominal airflow)	1,27	51,39	0,12	3,78	1,19	47,7	0,05	0,99	1,12	45,81	0,06	1,44
20	1. (min/heating mode)	0,28	61,11	0,02	0,4	0,26	57,78	0,01	0,1	0,23	54,72	0,01	0,2
	4.	0,84	55,53	0,07	1,71	0,75	51,48	0,04	0,45	0,7	49,5	0,05	0,63
	7. (nominal airflow)	1,17	52,29	0,1	3,15	1,04	48,51	0,05	0,72	0,98	46,62	0,05	1,17

		55/45				45/35				40/30			
Air intake temperature*	Airflow	Heating output	Exhaust air temperature	Water flow	Water pressure drop	Heating output	Exhaust air temperature	Water flow	Water pressure drop	Heating output	Exhaust air temperature	Water flow	Water pressure drop
°C	m3/h	kW	°C	m3/h	kPa	kW	°C	m3/h	kPa	kW	°C	m3/h	kPa
10	1. (min/heating mode)	0,25	47,16	0,03	0,3	0,19	37,71	0,03	0,2	0,17	33,12	0,02	0,1
	4.	0,76	41,94	0,06	1,53	0,57	33,57	0,05	0,99	0,47	29,16	0,04	0,72
	7. (nominal airflow)	1,05	39,06	0,09	2,79	0,79	31,41	0,07	1,71	0,65	27,36	0,05	1,26
15	1. (min/heating mode)	0,23	47,07	0,02	0,3	0,17	37,71	0,02	0,1	0,14	33,21	0,01	0,1
	4.	0,66	42,57	0,05	1,17	0,46	33,93	0,04	0,63	0,37	29,61	0,04	0,45
	7. (nominal airflow)	0,92	39,96	0,08	2,16	0,65	32,22	0,05	1,17	0,5	27,99	0,05	0,81
20	1. (min/heating mode)	0,18	46,89	0,03	0,2	0,14	37,89	0,01	0,1	0,11	33,21	0,01	0,1
	4.	0,56	43,11	0,05	0,9	0,36	34,29	0,05	0,45	0,27	29,97	0,03	0,18
	7. (nominal airflow)	0,77	40,86	0,07	1,62	0,5	32,76	0,05	0,81	0,36	28,62	0,03	0,27

Data - WATER EXCHANGER - HEATING



XROOM-250-HRV, ERV

		80/60				75/65				75/60			
Air intake temperature*	Airflow	Heating output	Exhaust air temperature	Water flow	Water pressure drop	Heating output	Exhaust air temperature	Water flow	Water pressure drop	Heating output	Exhaust air temperature	Water flow	Water pressure drop
°C	m3/h	kW	°C	m3/h	kPa	kW	°C	m3/h	kPa	kW	°C	m3/h	kPa
10	1. (min/heating mode)	1,68	73,8	0,07	3,2	1,61	70,9	0,14	10	1,58	70	0,1	4,8
	4.	2,87	68,1	0,12	8,1	2,78	66,3	0,27	26,1	2,71	64,9	0,17	12,3
	7. (nominal airflow)	4,38	61,8	0,22	16,9	4,26	60,7	0,4	55,7	4,16	59,2	0,26	26
15	1. (min/heating mode)	1,56	73,9	0,06	2,8	1,48	71,1	0,12	8,7	1,46	70,1	0,09	4,2
	4.	2,65	68,6	0,11	7	2,57	66,8	0,23	22,7	2,5	65,5	0,15	10,7
	7. (nominal airflow)	4	62,7	0,2	14,7	3,96	61,7	0,37	48,5	3,83	60,1	0,23	22,5
20	1. (min/heating mode)	1,43	74,1	0,05	2,4	1,36	71,4	0,11	7,5	1,34	70,3	0,08	3,6
	4.	2,44	69,1	0,1	6,1	2,35	67,4	0,21	19,5	2,28	66	0,13	9,1
	7. (nominal airflow)	3,71	63,6	0,148	12,7	3,63	62,6	0,3	41,6	3,49	61,1	0,21	19,2

		70/60				70/50				65/50			
Air intake temperature*	Airflow	Heating output	Exhaust air temperature	Water flow	Water pressure drop	Heating output	Exhaust air temperature	Water flow	Water pressure drop	Heating output	Exhaust air temperature	Water flow	Water pressure drop
°C	m3/h	kW	°C	m3/h	kPa	kW	°C	m3/h	kPa	kW	°C	m3/h	kPa
10	1. (min/heating mode)	1,48	66,1	0,13	8,8	1,42	63,9	0,06	2,4	1,32	60,2	0,08	3,6
	4.	2,55	61,7	0,22	22,9	2,41	58,8	0,11	6,1	2,26	55,7	0,13	9,2
	7. (nominal airflow)	3,94	56,6	0,35	48,8	3,66	53,3	0,16	12,8	3,45	50,8	0,2	19,4
15	1. (min/heating mode)	1,36	66,3	0,12	7,6	1,3	64	0,06	2,1	1,2	60,3	0,07	3
	4.	2,34	62,3	0,21	19,6	2,19	59,2	0,1	5,2	2	56,2	0,12	7,7
	7. (nominal airflow)	3,61	57,5	0,32	41,8	3,32	54,1	0,15	10,8	1,07	60,5	0,06	2,5
20	1. (min/heating mode)	1,23	66,5	0,11	6,4	1,17	64	0,05	1,7	1,07	60,5	0,06	2,5
	4.	2,13	62,8	0,19	16,6	1,97	59,7	0,09	4,3	1,82	56,7	0,11	6,3
	7. (nominal airflow)	3,27	58,5	0,29	35,3	2,98	55	0,13	8,9	2,77	52,6	0,16	13,2

		55/45				45/35				40/30			
Air intake temperature*	Airflow	Heating output	Exhaust air temperature	Water flow	Water pressure drop	Heating output	Exhaust air temperature	Water flow	Water pressure drop	Heating output	Exhaust air temperature	Water flow	Water pressure drop
°C	m3/h	kW	°C	m3/h	kPa	kW	°C	m3/h	kPa	kW	°C	m3/h	kPa
10	1. (min/heating mode)	0,85	51,9	0,07	3,5	0,84	41,7	0,07	3,5	0,7	36,7	0,06	2,7
	4.	1,44	49	0,13	8,8	1,42	38,9	0,12	9	1,2	34,2	0,1	6,7
	7. (nominal airflow)	2,2	45,9	0,19	18,5	2,17	35,7	0,19	18,8	1,81	31,5	0,16	14
15	1. (min/heating mode)	0,97	51,7	0,08	4,4	0,71	41,8	0,06	2,6	0,57	36,7	0,05	1,9
	4.	1,66	48,6	0,15	11,3	1,2	39,3	0,1	6,7	0,97	34,6	0,08	4,7
	7. (nominal airflow)	2,54	45	0,22	23,9	1,83	36,6	0,16	13,9	1,46	32,3	0,13	9,6
20	1. (min/heating mode)	1,1	51,5	0,1	5,5	0,85	41,8	0,05	1,9	0,344	36,5	0,04	1,2
	4.	1,88	48	0,16	14	0,98	39,7	0,09	4,7	0,74	34,8	0,06	2,9
	7. (nominal airflow)	2,88	44,1	0,25	29,7	1,48	37,4	0,13	9,6	1,11	33	0,1	5,9

Data - WATER EXCHANGER - COOLING



Maximum operating pressure for the heater **1.6 MPa**

The connection dimension of both heat exchangers is an external thread **G 3/4"**

XROOM-100-HRV, ERV

Air intake temperature*	Airflow	7/12				12/16				16/20			
		Cooling output - total/sensible	Exhaust air temperature	Water flow	Water pressure drop	Cooling output - total/sensible	Exhaust air temperature	Water flow	Water pressure drop	Cooling output - total/sensible	Exhaust air temperature	Water flow	Water pressure drop
°C	m3/h	kW	°C	m3/h	kPa	kW	°C	m3/h	kPa	kW	°C	m3/h	kPa
24 (indoor condition 23°C extract /30°C supply)	1. (min/cooling mode)	0,3/0,15	12,1	0,06	3,5	0,25/0,12	14,7	0,09	2,8	0,18/0,05	18,7	0,05	0,9
	4.	0,7/0,1	12	0,14	6,8	0,5/0,18	15,6	0,13	5,7	0,35/0,11	19,4	0,1	2,3
	7. (nominal airflow)	0,9/0,35	14	0,19	11,7	0,7/0,25	16,7	0,17	9,7	0,4/0,14	19,9	0,1	3,9
28 (indoor condition 25°C extract /35°C supply)	1. (min/cooling mode)	0,40/0,2	12	0,9	7	0,3/0,15	14,7	0,13	5,9	0,25/0,13	18,5	0,1	3,6
	4.	1/0,32	12,5	0,19	12	0,8/0,22	16,2	0,2	12	0,5/0,19	19,6	0,15	7,2
	7. (nominal airflow)	1,4/0,45	14,5	0,26	20,8	1,1/0,35	17,7	0,27	20,6	0,8/0,25	20,7	0,2	12,2

- the condensate is drained through a hose from the condensate tray into exhausts duct, from where it flows towards the outlet
- all supply and discharge pipes to the unit must be insulated otherwise there is a risk of condensation on the surfaces

!!! IF YOU WANT TO USE COOLING FUNCTION YOU MUST SWITCH SETTING HEAT/COOL AT CONTROL PANEL!!!

Data - WATER EXCHANGER - COOLING



XROOM-250-HRV, ERV

Air intake temperature*	Airflow	7/18				10/20				16/23			
		Cooling output - total/sensible	Exhaust air temperature	Water flow	Water pressure drop	Cooling output - total/sensible	Exhaust air temperature	Water flow	Water pressure drop	Cooling output - total/sensible	Exhaust air temperature	Water flow	Water pressure drop
°C	m3/h	kW	°C	m3/h	kPa	kW	°C	m3/h	kPa	kW	°C	m3/h	kPa
24 (indoor condition 23°C extract /30°C supply)	1. (min/cooling mode)	0,8/0,32	12,2	0,08	3,2	0,5/0,2	15	0,07	2,6	0,3/0,1	20,2	0,04	1,5
	4.	1,5/0,54	14	0,13	12,1	1,1/0,41	16,4	0,11	9,3	0,4/0,17	21	0,07	3,9
	7. (nominal airflow)	2/0,72	15,6	0,18	21,2	1,5/0,55	17,6	0,15	16,2	0,6/0,24	21,4	0,1	6,9
28 (indoor condition 25°C extract /35°C supply)	1. (min/cooling mode)	1,2/0,44	11,5	0,11	9,3	1/0,3	14,1	0,11	8,6	0,6/0,2	18,8	0,11	8,7
	4.	2,2/0,73	14,2	0,19	24,2	2/0,62	16,4	0,18	21,9	1,2/0,4	20,5	0,19	21,4
	7. (nominal airflow)	3/1	16,4	0,27	43	2,7/0,83	18,3	0,25	38,8	1,8/0,5	21,6	0,25	37,2

- the condensate is drained through a hose from the condensate tray into exhausts duct, from where it flows towards the outlet
- all supply and discharge pipes to the unit must be insulated otherwise there is a risk of condensation on the surfaces

!!! IF YOU WANT TO USE COOLING FUNCTION YOU MUST SWITCH SETTING HEAT/COOL AT CONTROL PANEL!!!

Packaging and dimensions Xroom

	Type	Coding	Weight		Package size (width x length x height)	Pieces on a pallet (max. stackability)
			Brutto	Netto		
			kg		m	pcs
Xroom-100	Xroom unit	XR1-010-ECS0HRX...	19,2	16,3	1,05x0,7x0,31	5
		XR1-010-ECVxHRX...	21,2	18,3		
		XR1-010-ECE1HRX...	22,2	19,3		
		XR1-010-ECS0HRP...	19,7	16,8		
		XR1-010-ECVxHRP...	21,7	18,8		
	XR1-010-ECE1HRP...	22,7	19,8			
	Necessary accessories	XR1-010-DUCT-1	1,4	1,2	0,6x0,4x0,21	40
Xroom-250	Xroom unit	XR1-025-ECS0HRX...	41,1	36	1,6x0,84x0,36	5
		XR1-025-ECVxHRX...	44,5	39,4		
		XR1-025-ECE1HRX...	46,3	41,2		
		XR1-025-ECS0HRP...	42,1	37		
		XR1-025-ECVxHRP...	45,5	40,4		
	XR1-025-ECE1HRP...	47,3	42,2			
	Necessary accessories	XR1-025-DUCT-1	1,9	1,7	0,6x0,4x0,21	40

Xroom unit

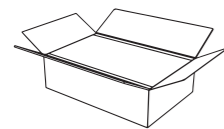

Package includes:

- UnitXroom
- Mounting material
- Quick manual
- Safety instruction

Necessary accessories

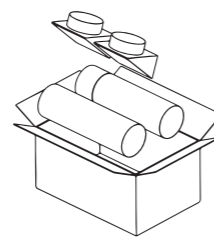

Package includes:

- Duct 500mm
- Duct 500mm with flap
- Air grill
- Air grill with flap



XR-010
ø 125 mm
XR-025
ø 150 mm

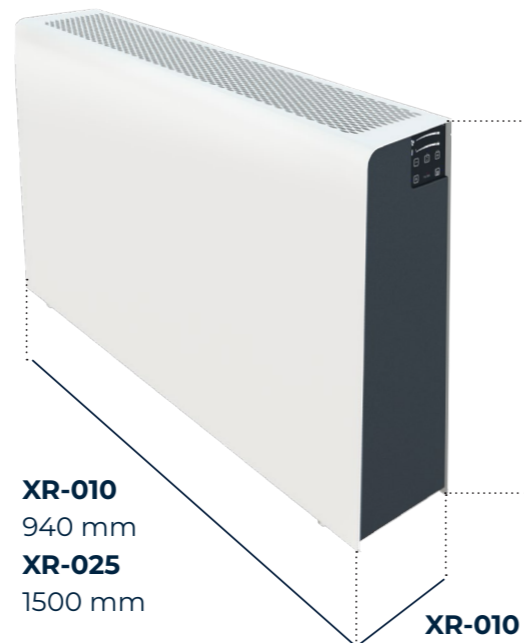

XR-010
940 mm
XR-025
1500 mm

XR-010
580 mm
XR-025
720 mm

XR-010 200 mm
XR-025 250mm



Instalation Xroom

Xroom has to be operated in indoor and dry space with temperature between +5°C up to +40°C. The unit can be installed only in horizontal position. When breaking the security distances the unit can operate improperly and the fans might come damaged, the noise level might increase or the service-access might get blocked off. Xroom equipped with heat exchanger (HRV) can produce the condensate and it is necessary to realized, that the condensate might leak thru the bottom hole thru the outlet grill outside. Xvent recommends the unit equipped with enthalpic heat exchanger, which does not the create any condensate.

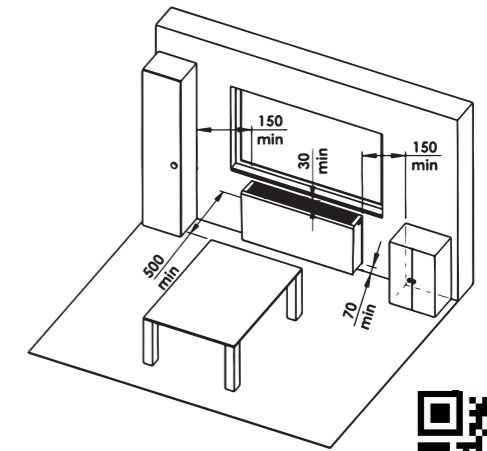

Installation and service manual on our website

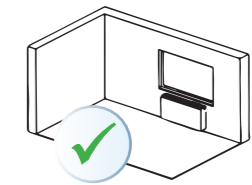
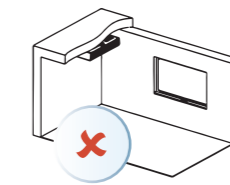
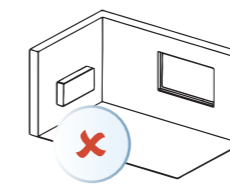
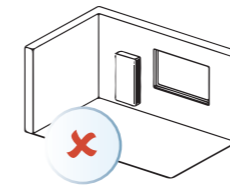

Necessary accessories

Assembly of ducts and air grilles

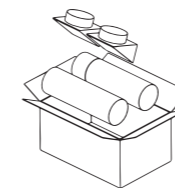

Unit type	DUCT-SYSTEM
Xroom - 100	XR1-010-DUCT-1
Xroom - 250	XR1-025-DUCT-1

Accessories

Filters Xroom

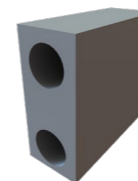

Unit type	M5 - COARSE 70% ISO 16890	F7 - ePM1 60 % ISO 16890
Xroom - 100	XR-010-FILTER-M5	XR-010-FILTER-F7
Xroom - 250	XR-025-FILTER-M5	XR-025-FILTER-F7

Instalation EPS box

Unit type	EPS-BOX
Xroom - 100	XR-010-EPS-BOX
Xroom - 250	XR-025-EPS-BOX

Radon - AQS

Unit type	AQS RADON
Xroom	XR-AQS-RADON

Coding of unit **Xroom**

Types XROOM-100 a XROOM-250

XR1-010-ECS0HRXCOS-0A0

- 0** reserve
- A** front cover color RAL 9003
- B** front cover color RAL 7016
- 0** design type
- S** standard control
- W** wifi control (in preparation)
- A** antivandal (in preparation)
- CO** AQS CO₂
- CR** AQS CO₂ + RH
- X** without preheater
- P** with preheater
- HR** heat recovery
- ER** heat and moisture recovery
- S0** without heater
- V1** water heater
- VC** water changeover
- E1** electric heater
- EC** fan with EC motor

010 airflow 100m³/h

025 airflow 250m³/h

XR1 unit Xroom - mark 1

Available in two colors



In offices...
...for higher productivity..



In living rooms...
...for better air quality...



In hotels...
...for better sleeping...



In schools...
...for better concentration...



In hospitals...
...fresh air without opening windows...



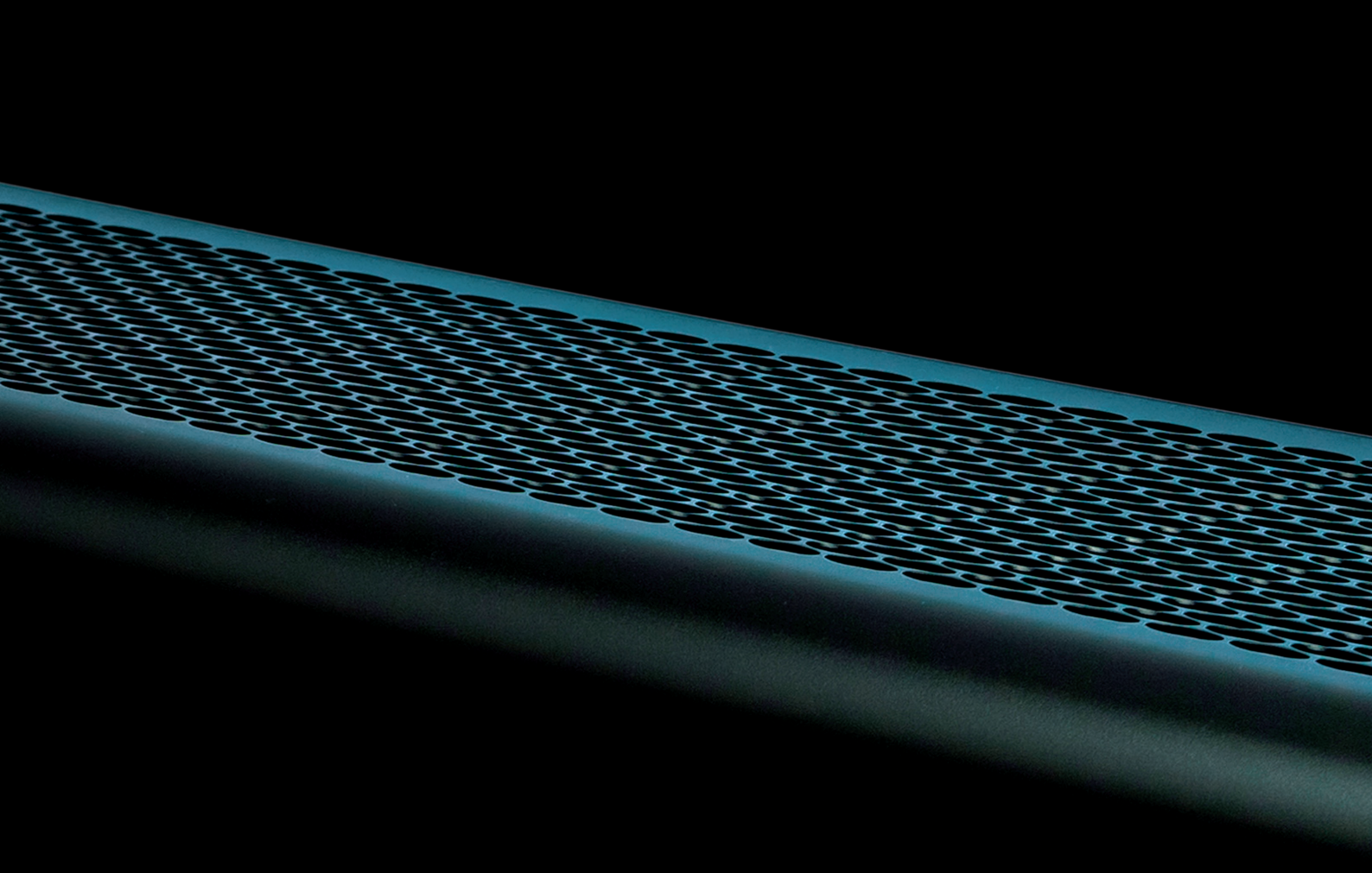

Beauty in simplicity

+420 467 070 233
office@xvent.cz

Xvent s.r.o.
Poděbradská 289
53009 Pardubice
Czech Republic

www.xvent.cz